





ACE 105

1U - 19" power racks for extended
power



DISCOVER →

Product Highlights

-  Scalable
-  Modular, from 1 to 5 power converter
-  Compact design
-  Complete an existing design

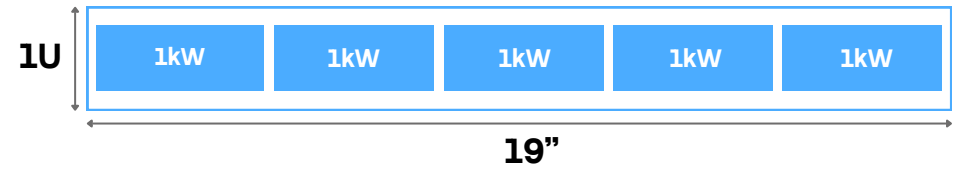

Boost Your Power

Pair the ACE105 with the ACE104 for Up to 9 kW



ACE105

1kW - 48 Vdc
Rectifier/Converter

Modular, easy to integrate power rack

The **ACE105** is a robust 19" power rack solution designed for demanding industrial applications.

Built for **flexibility** and **easy integration**, it offers hot-swappable rectifiers slots.

Equipped with **5 configurable power slots**, the ACE105 supports:

- Our DC/DC converters (48V – 1kW)
- Or our ECOR converters (AC/DC input, 48V – 1kW output)

The ACE105 can be paired with our **ACE104** 1U rack, adding four additional power slots and one monitoring slot.

Moreover, it can be combined with any other **power rack from the CE+T group**, allowing the solution to be extended in terms of power capacity or conversion level.

The ACE105 can also be integrated with our **UCC** (Universal Command & Control) product to deliver additional power for an asset monitoring system.

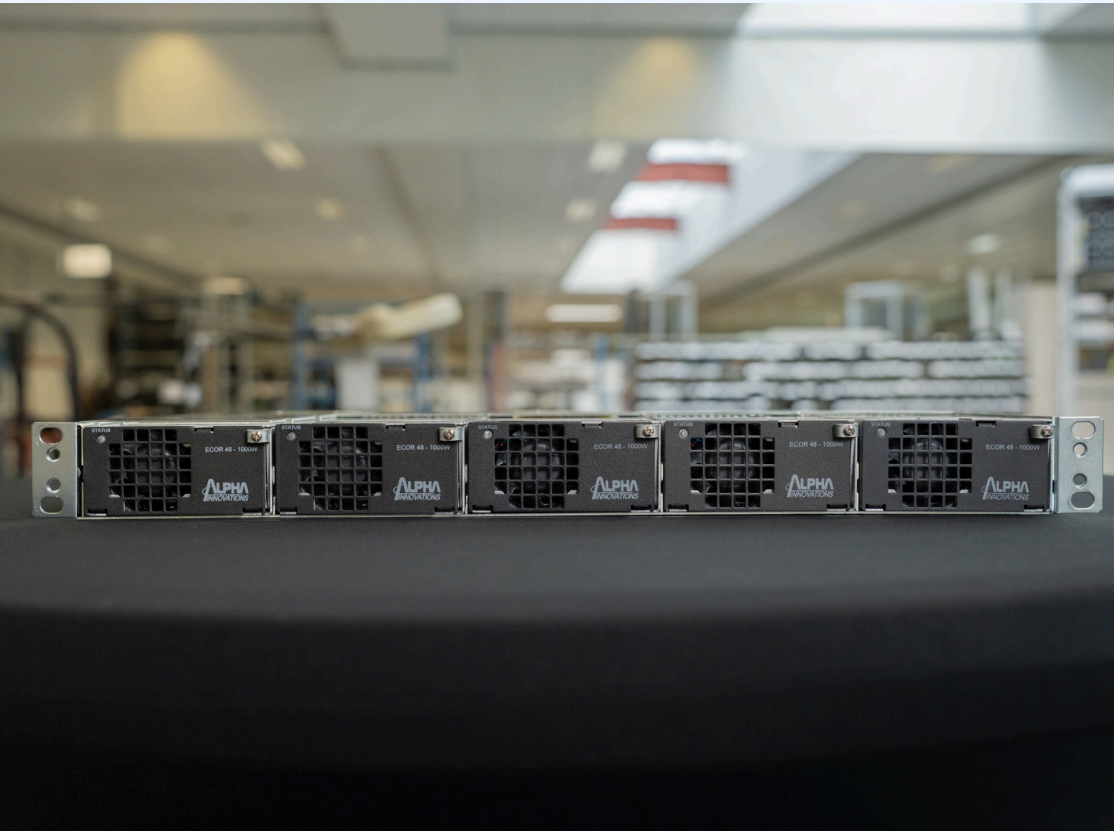

Specifications

Electrical

Input	
Input Standard Voltage AC	100 to 240 Vac
Input Standard Voltage DC	100 to 340 Vdc
Input Voltage Maximum	300 Vac / 410 Vdc
Input Current	Refer to Converter Module (CDCWI1048 or ECOR1048TN)
Efficiency	Refer to Converter Module (CDCWI1048 or ECOR1048TN)
Output DC	
Output Voltage	-40.5 to -58 Vdc
Output Power (per module)	Refer to Converter Module (CDCWI1048 or ECOR1048TN)
Output Power Maximum	5 kW (5 x 1 kW per module)
Output Current	110 A max
Battery if used with ACE104	
LVD output	80 A max

Part Number

Family	9400 062 00000
Specific Configuration	9400 062 001xx

Environmental

Operating Temperature	-20 to +55 °C
Extended (derated output power)	-40 to +70 °C
Storage Temperature	-40 to +85 °C
Humidity Operating	20 to 80% RH non-condensing
Humidity Operating Option	20 to 95% RH non-condensing
Humidity Storage	10 to 95% RH non-condensing
Elevation	Up to 3000 m
Cooling	Forced air cooling (Front to rear) Min free space before and behind the sub-rack = 15mm

Features

Protection	<ul style="list-style-type: none"> Internal rectifier Fuse : 10A delayed in Lin External fuses or breaker : 20A max DC or 32 A max AC Grounding studs for protective earth protection (2x M5 studs)
Customization if combined with ACE104 or UCC which has monitoring unit	<ul style="list-style-type: none"> Specific configuration (alarm, function, ...) Alarming on specific signals, events, alarms... Real-time data visualization Customization through Python scripting Remote control and access

Standards

Safety	<ul style="list-style-type: none"> CE marked IEC 62368-1 (formerly IEC 60950-1) CEBEC and c-SGS-us markings
Environment	<ul style="list-style-type: none"> RoHS compliant
EMC	<ul style="list-style-type: none"> EN 61000-6-1 ETSI EN300386 EN 61000-6-3

Mechanical

Dimensions (mm)	44 H (1U) x 440 W x 259 D	
Dimensions (inches)	1.75 H x 17.3 W x 10.2 D	
Mounting	19" or ETSI	
Weight (kg)	Shelf	2.5 (5.5 lb)
	Converter Module	1.16 (2.56 lb)
Connections	Load	M5 Stud
	Battery	M5 Stud
	Input	Spring cage terminal block (5 x 2 poles)
	Signals (rear)	2X 6-poles Molex 2X 8-poles RJ45

Mechanical dimensions

Front view

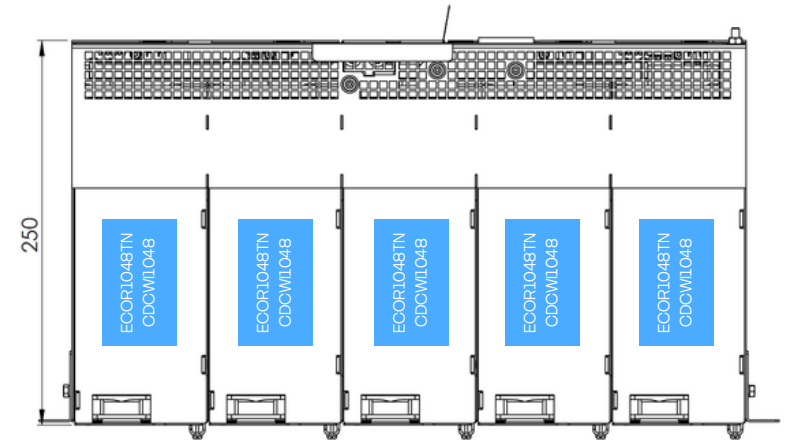

Rear view

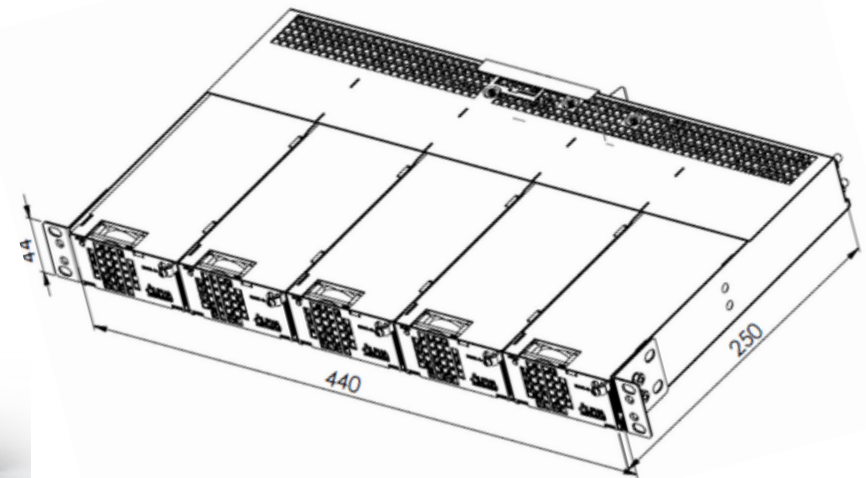
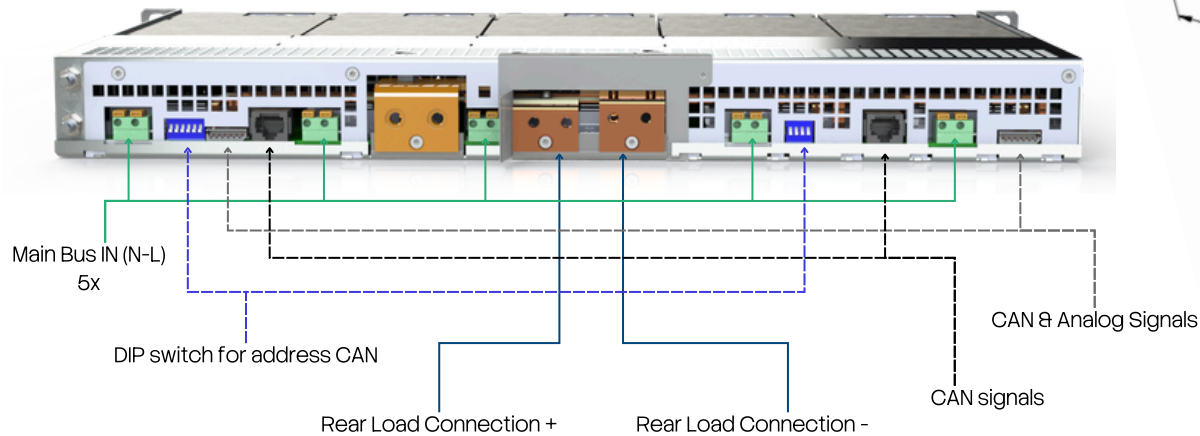

Connectors details

8-poles RJ45

1	CANH
2	CANL
3	CAN_GND
4 to 8	Not connected

6-poles Molex connectors

1	V_PROG
2	SHARING
3	0V signal
4	CANL
5	CANH
6	CAN_GND

Product overview



Slot block for converters.

ECOR1048TN

- **AC in** : 90 to 265 Vac
- **DC in** : 85 to 408 Vdc
- **DC out** : 40.5 to 58 Vdc
- **Efficiency** : 96 %
- **Power** : 1000 W



CDCWI1048

- **DC in** : 20 to 72 Vdc
- **DC out** : 40.5 to 58 Vdc
- **Efficiency** : 90 %
- **Power** : 1000 W



Rear connections Options

- BUSBAR ACE105 to ACE104
- BUSBAR ACE105 to ACE105

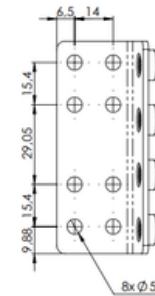

Related items

Modular & Configurable Power Racks

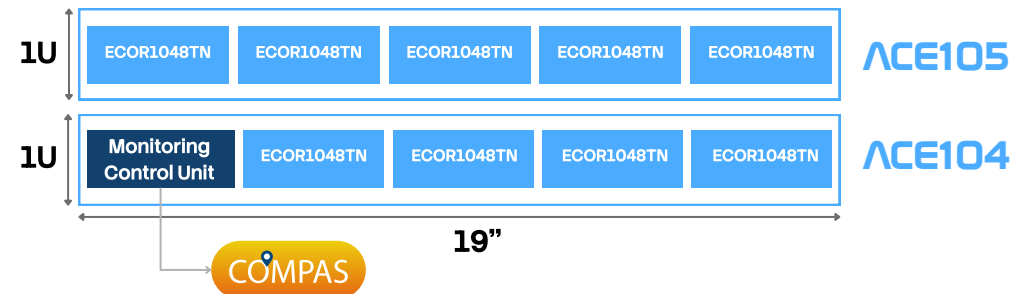

ACE Shelves Series

The **ACE Series** is a compact line of 19" power racks from Alpha Innovations, with full front access, hot-swappable rectifiers, advanced monitoring, and flexible battery management, ideal for space-constrained, high-reliability applications.

More info ?

Address

Avenue Alexander
Fleming, 1
1348 Louvain-la-Neuve
Belgium

Email

rfq@alphainnovations.eu

Phone

+32 10 438 211

Website

www.alphainnovations.eu